

Vue de A

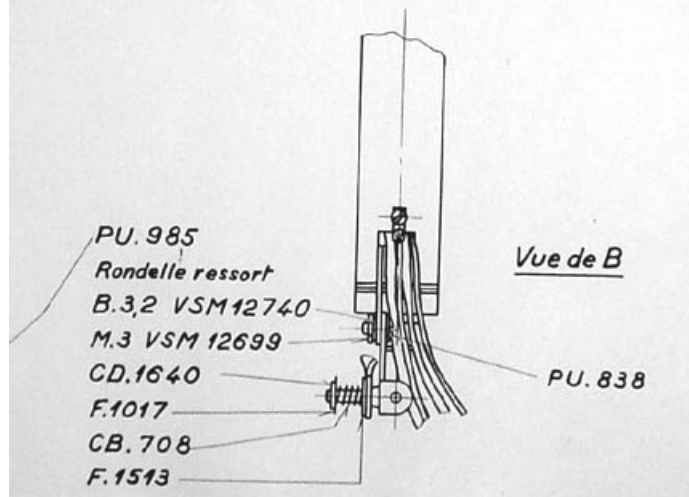

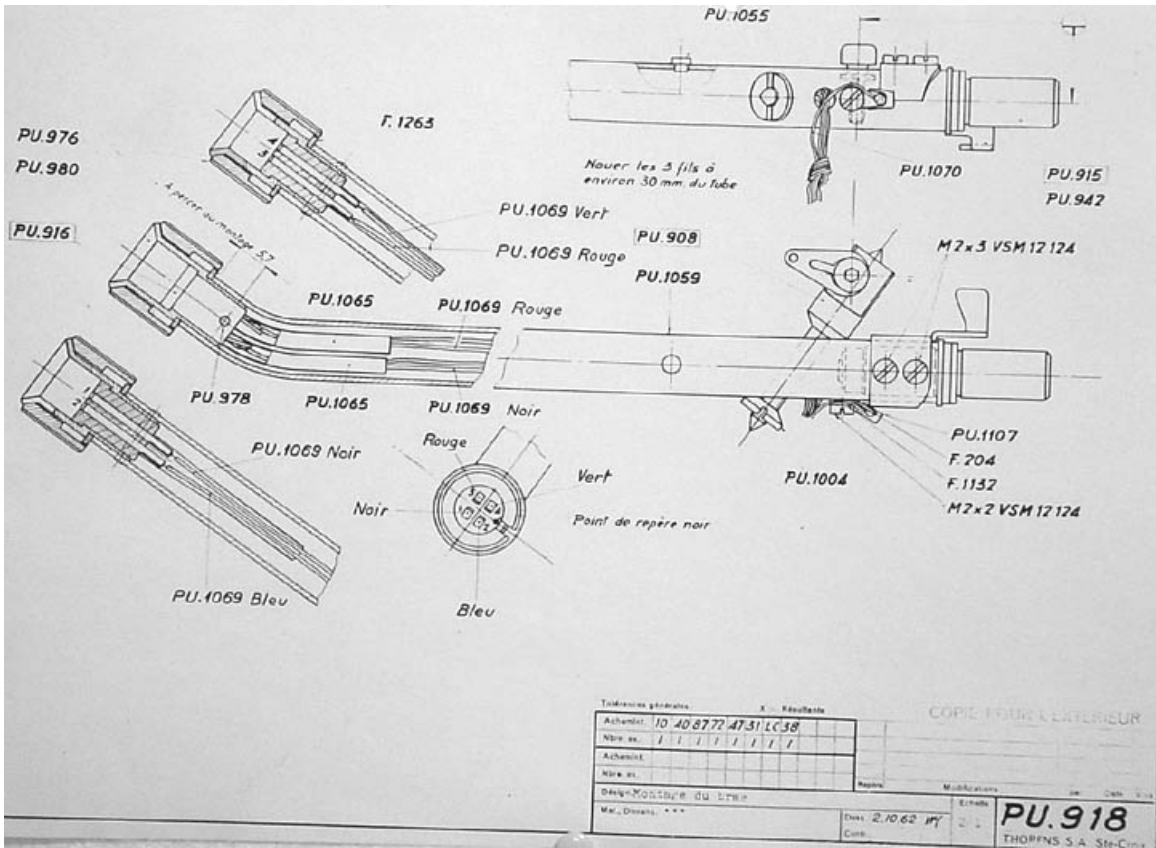

Tolérances générales X - Révisé

COPIE POUR L'ATELIER

Achevé le	10 40 87 72 47 51 LC 38
Nbr ex	1 1 1 1 1 1 1 1
Achevé le	
Nbr ex	

Dessin-Montage du tracé
 M. D. Dessin : ***
 Date : 2.10.62
 Cont. : ***
 Echelle : 2 : 1
PU.918
 THOMPINS S.A. Ste-Croix

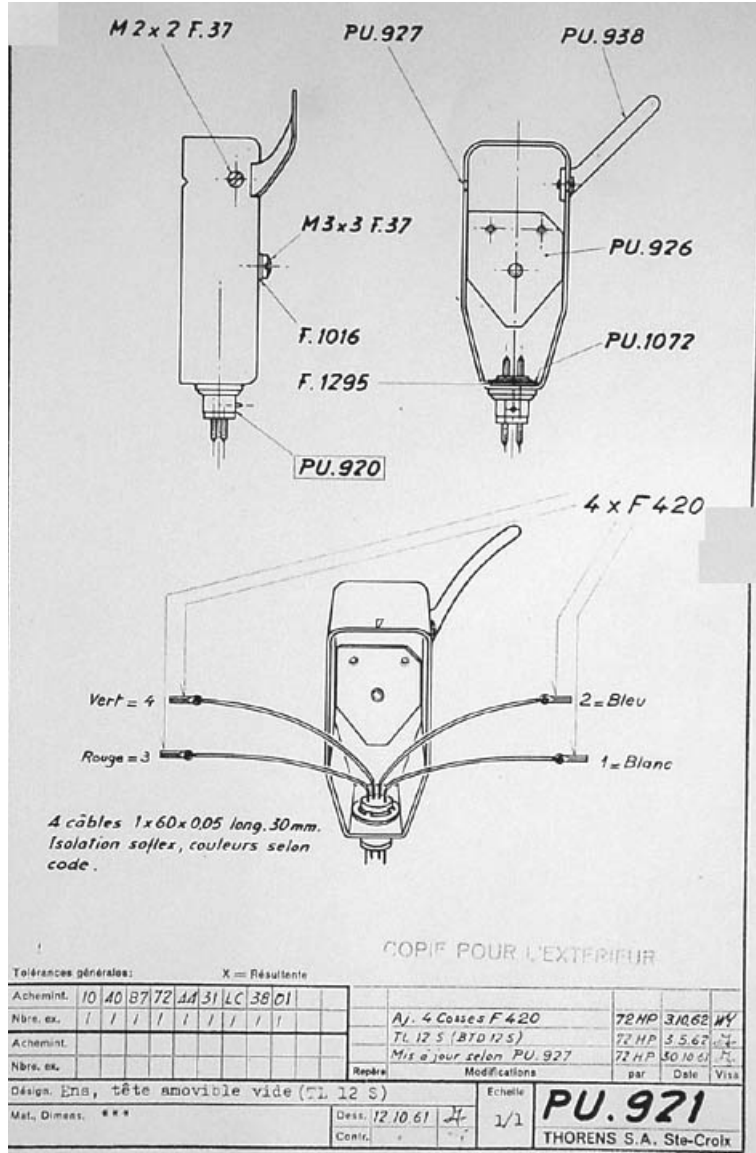

Tolerances générales: X = Résultante								COPIE POUR L'EXTERIEUR									
Achemint.	10	40	87	72	41	31	LC	38	01								
Nbre. ex.	1	1	1	1	1	1	1	1	1								
Achemint.																	
Nbre. ex.																	
										Repère	Modifications	par	Date	Visa			
Désign. Ens, tête amovible vide (Cl. 12 S)										Echelle		PU.921					
Mat. Dimens. ***										1/1							THORENS S.A. Ste-Croix
										Dess. 12 10 61 H							
										Contr. *							

PU.926

F.1016

M.3x3 F.37

PU.924

2 x F.1132

2 x PU.999

2 x M2 x 7 F.37

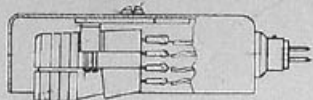

Aligner le saphir sur les repères du capot

Cartouche Shure M77M-S

Vert = 4

Rouge = 3

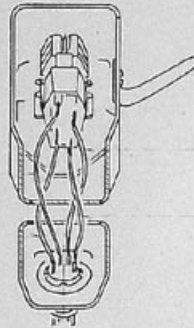

2 = Bleu

1 = Blanc

Tolerances générales

X = Resultate

Assemblé									
Nbre. ex.									
Assemblé									
Nbre. ex.									
Design Montage cart. Shure Stereo				Echelle		PU.1096			
Mat. Dimens. *****				Dess. 1910.62 W		1:1		THORENS S.A. Ste-Croix	
				Coup.					

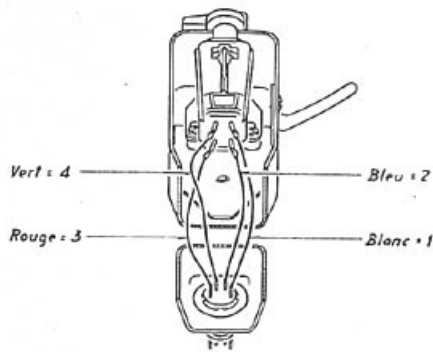
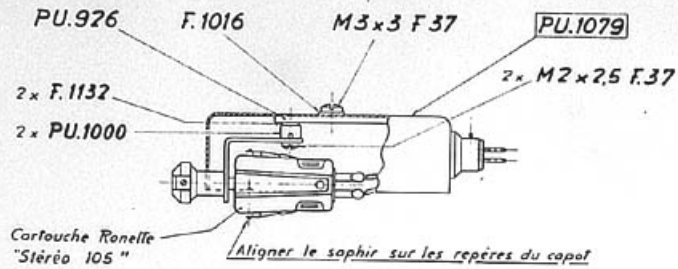

4 câbles 1x60x0,05 long. 30 mm.
 Isolation soflex, couleurs selon code.

COPIE POUR L'EXTERIEUR

Tolérances générales:										X = Résultante	
Achemin.											
Nbre. ex.											
Achemin.	10	40	87	72	31	LC	38				
Nbre. ex.	/	/	/	/	/	/	/				
Désign. Montage cart. Ronette stéréo (21 12 S)										Echelle	
Mat. Dimens. ***										Dess. 25. 5. 62 H	
Conté.										1/1	
										PU.1093	
										THORENS S.A. Ste-Croix	